

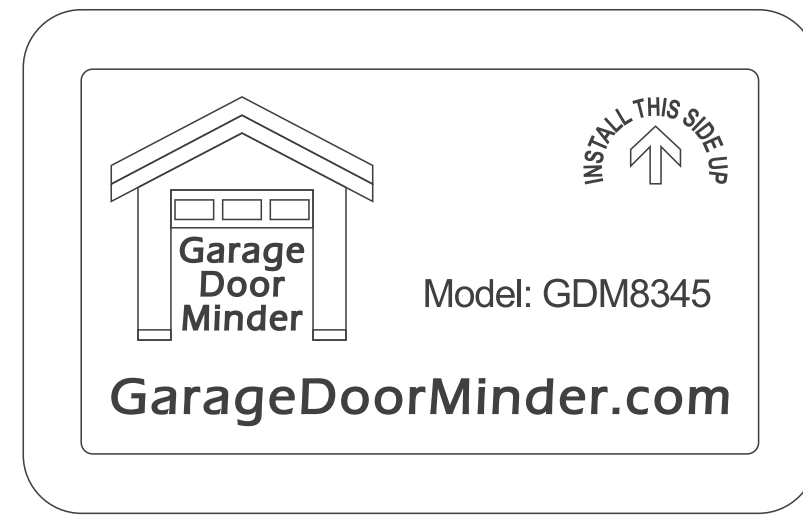

GarageDoorMinder™

Installation Instructions

Included Components



Transmitter

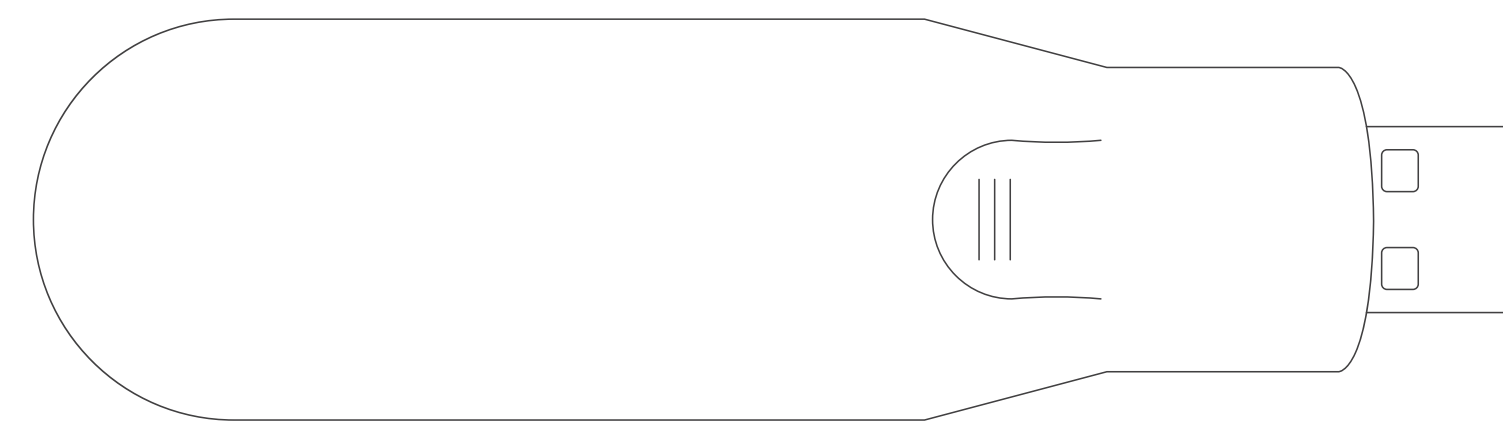

Receiver

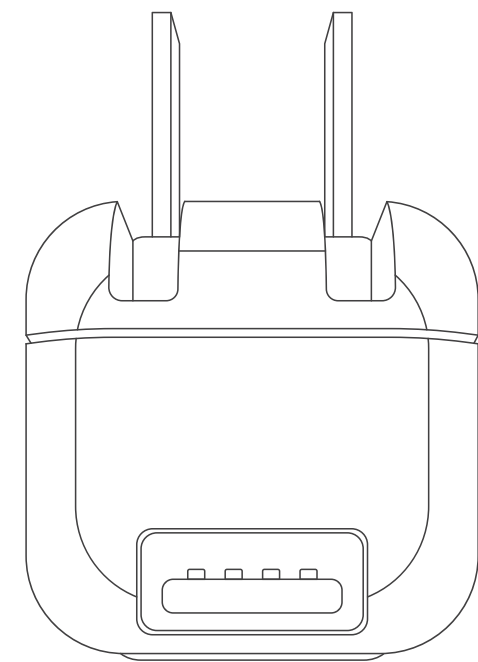

Wall Plug

Garage Door Minder Installation

1. **Remove from packaging:** Select location for Transmitter on smooth surface of garage door at highest possible point. (figure-1). Use provided alcohol swab to clean surface. Allow a couple minutes too dry. Locate battery pull tabs and pull in direction of arrow. (figure-2) Peel off velcro backing and stick to metal surface with arrow facing up. You're all done with the transmitter installation.

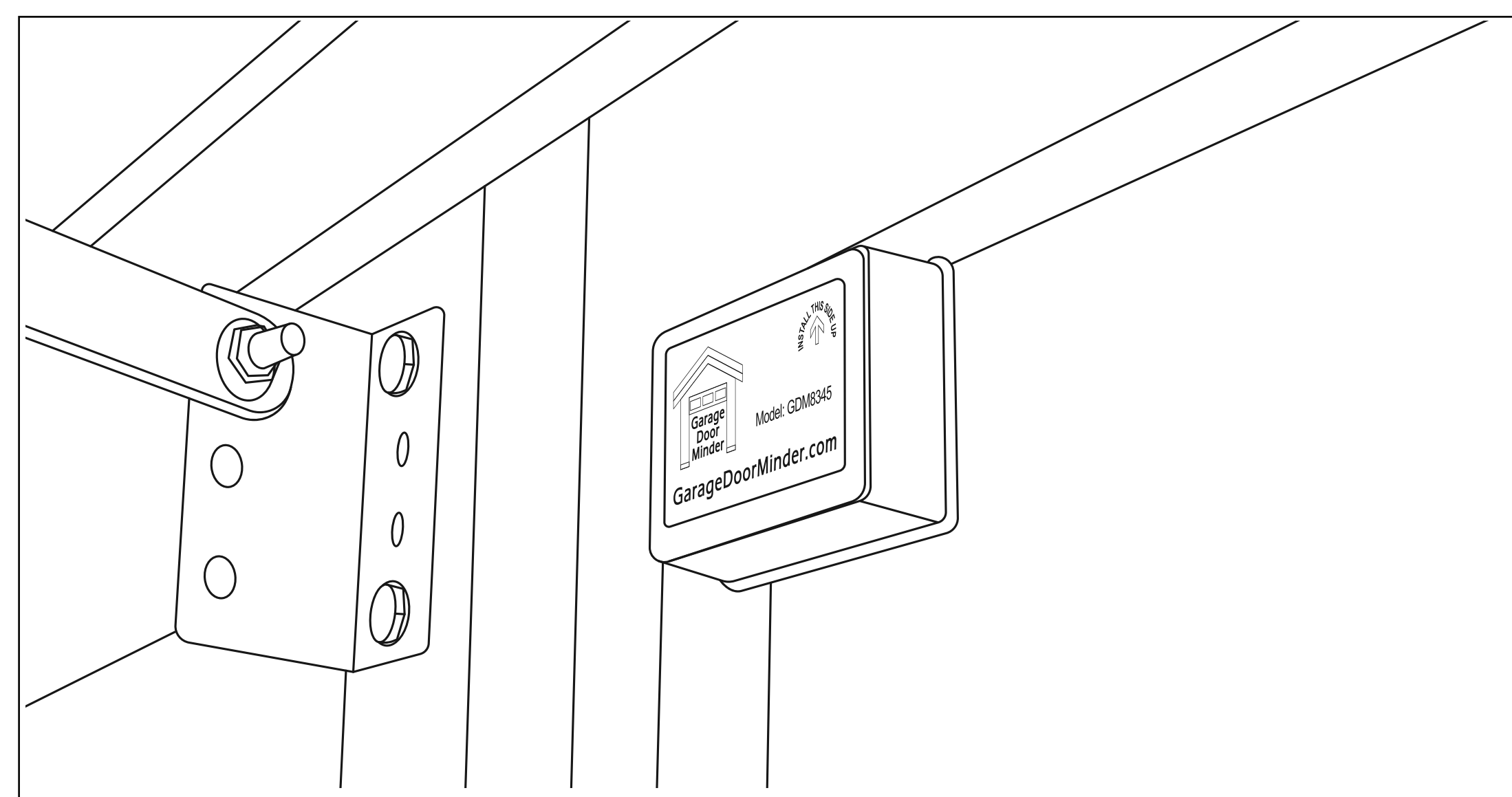

Figure - 1

2. **Battery replacement:** Remove screw on the back cover and lift out batteries. Replace with Er14250 also available on garagedoorminder.com

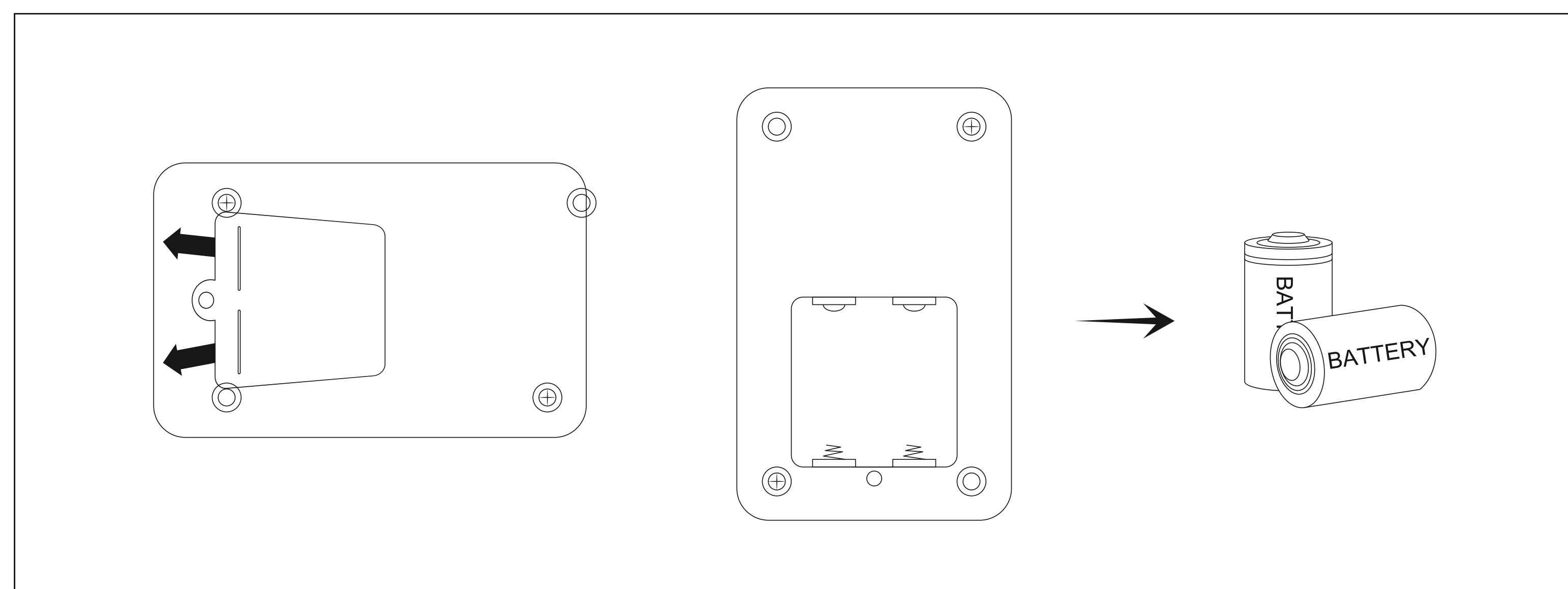

Figure - 2

3. Now plug in the provided wall plug and light stick in side your house (figure-3). That's it Garage Door Minder is Installed. When your door opens your light stick will blink and beep if you have the beeper function turned on. See detailed programming for your light stick below.

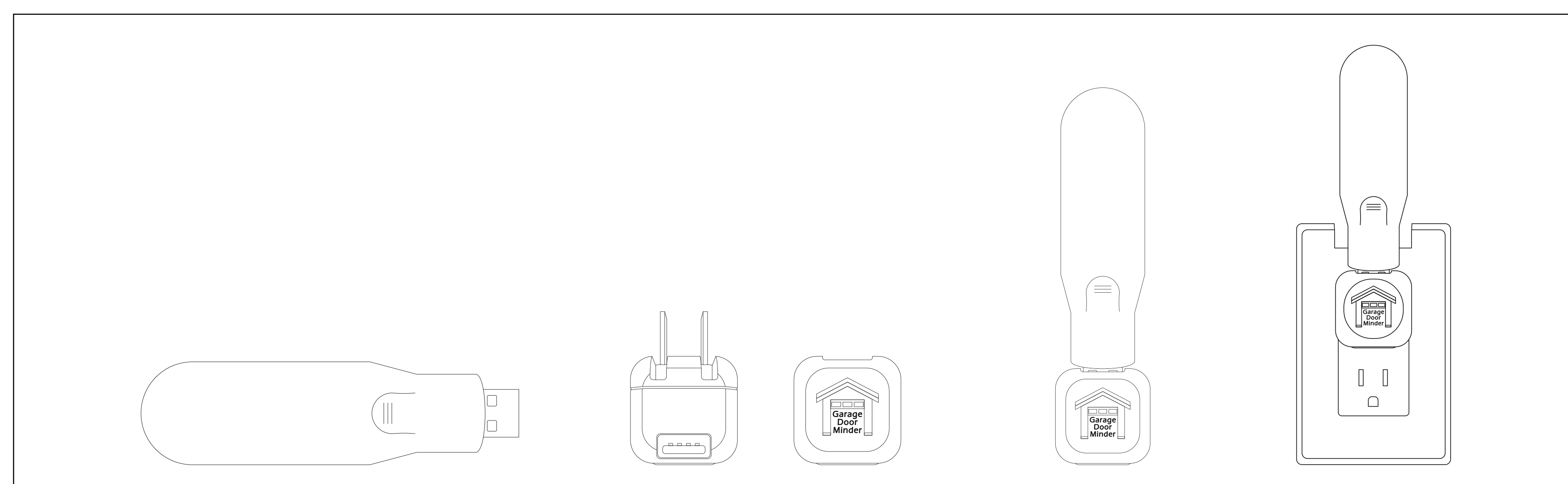
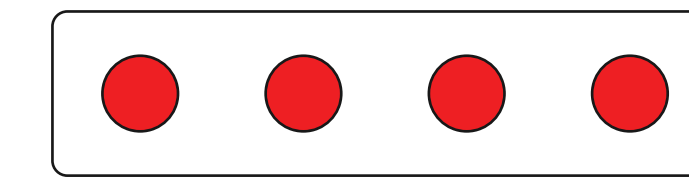

Figure - 3

Light Stick Receiver Programming

1) Operation manual light stick receiver

- LED's will blink once, when power is on.



- LED's will continuously blink when door is open and stop blinking when door is closed.

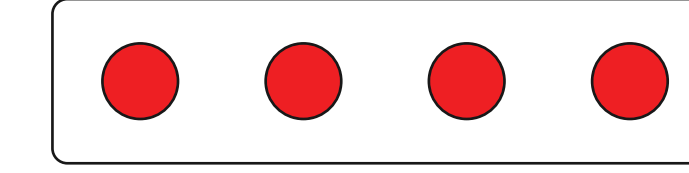

- Deactivate beeper option.

This option is set if you press & hold the button for 1 ~ 3 seconds. You will see the first LEDs come on, then let go now beeper function is disabled (OFF)

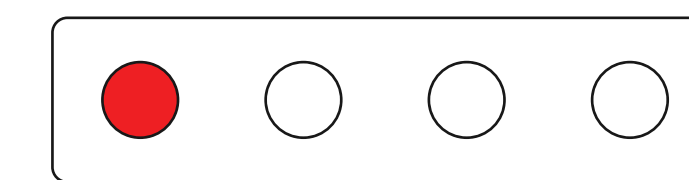

- Activate beeper.

This option is set if you press & hold the button for 4 ~ 7 seconds. You will see 1st and 2nd LEDs light up when you see 2nd LED light up let go of button. Beeper is now activated (ON)

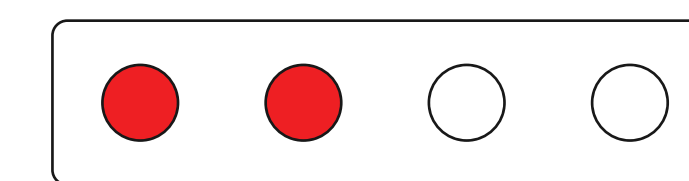

- Enter pairing mode.

This option is set if you press & hold the button for 8 ~ 11 seconds. You will see the 1st, 2nd and 3rd LEDs come on. Release button after the 3rd LED come on. You are now in pairing mode. The receiver can now pair with transmitter which must be within 12 inches during pairing mode. Turn transmitter label facing down to mimic door open. Light stick receiver will blink 3 times when device are paired. For pairing multiple light stick receivers repeat steps for each one. Also for multiple Transmitter paired with light stick receivers repeat same steps. Pairing mode will rest back to default after 30 seconds.

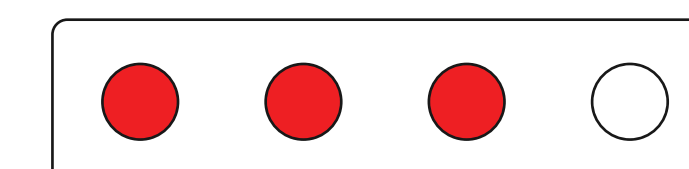

- Reset and clear all paired devices.

This option is set if you press & hold the button over 20 seconds. When released the first and fourth LEDs are on. The 2nd and 4th lights will go out on their own. The receiver light stick is reset.

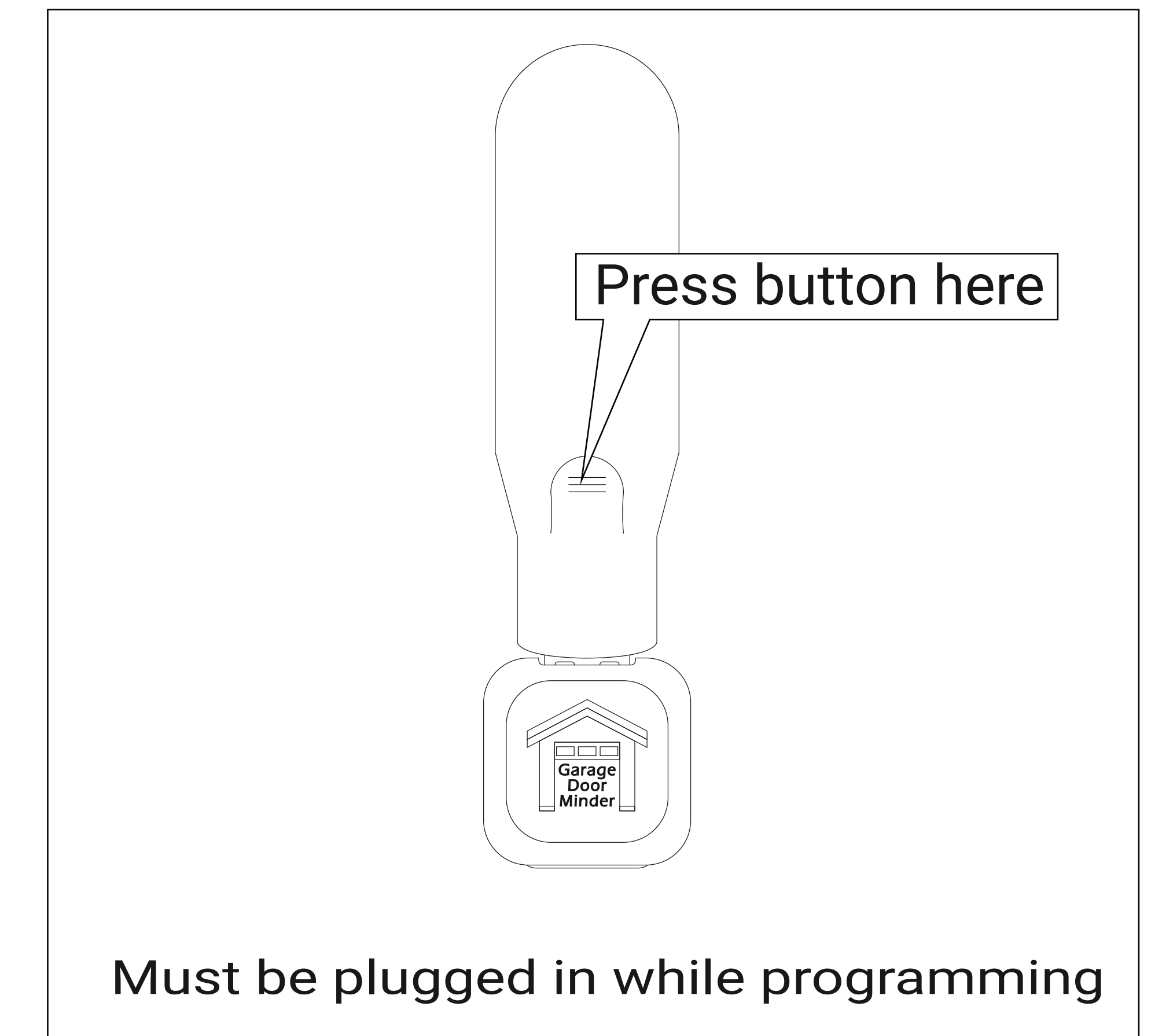
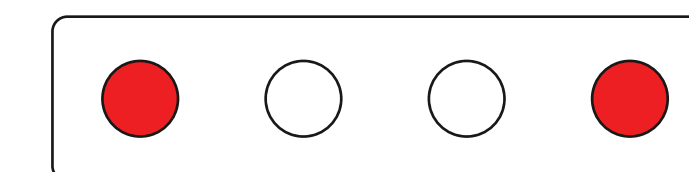

Figure - 4

Download the FREE app!

- Available for Android and iOS users
- Search for Garage Door Minder



App Instructions

Download the app and turn on Bluetooth. When prompted, allow the app to access Bluetooth. Android users may also need to allow the app to run in the background. Tap the to access settings and adjust alerts.

For online instructions and video instructions please visit Garagedoorminder.com



www.GarageDoorMinder.com
(916) 640-3960 • info@garagedoorminder.com